

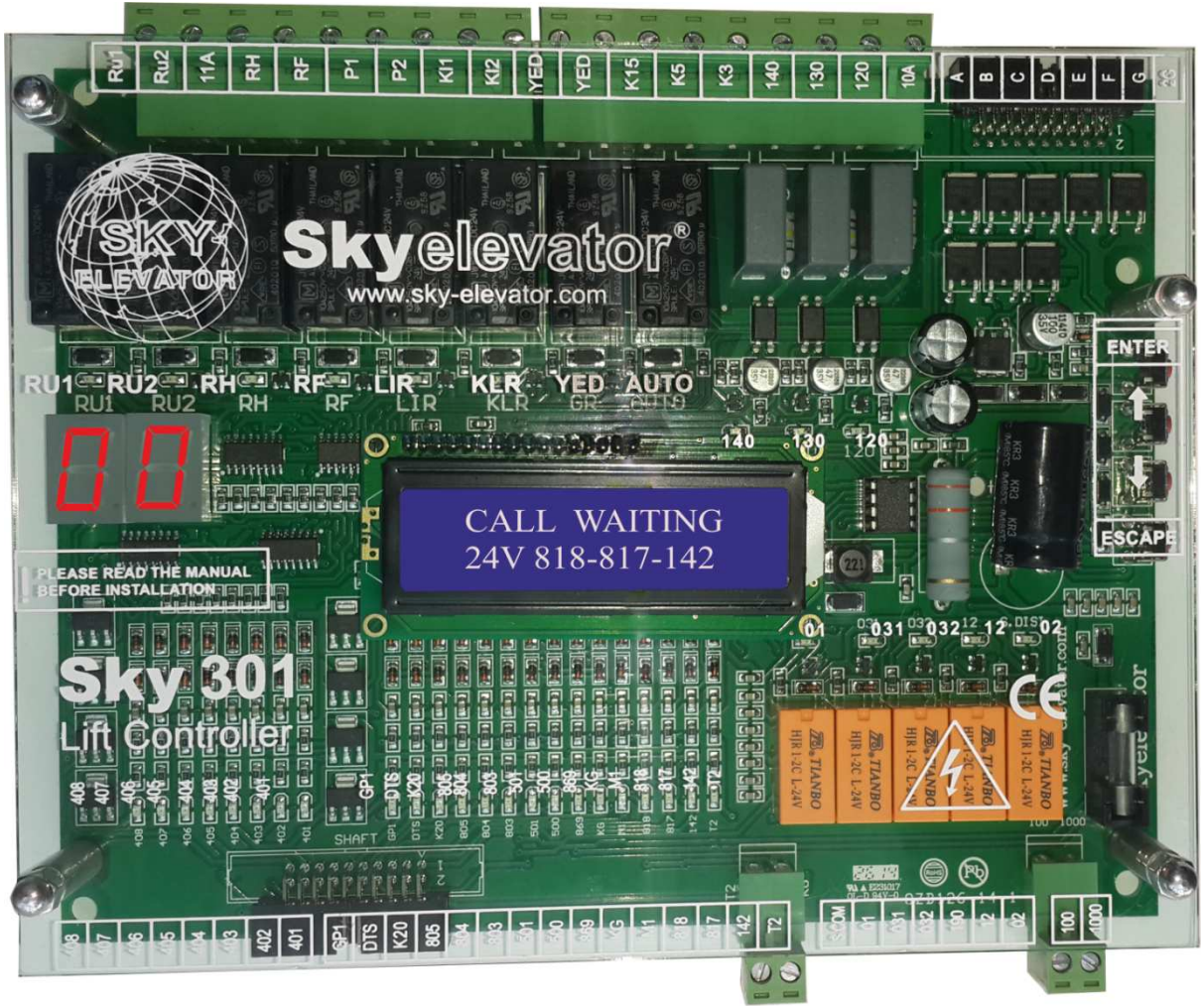

# Sky

Elevator

www.sky-elevator.com



## Sky-401

### ASANSÖR KUMANDA KARTLARI TEKNİK ÇIZIM

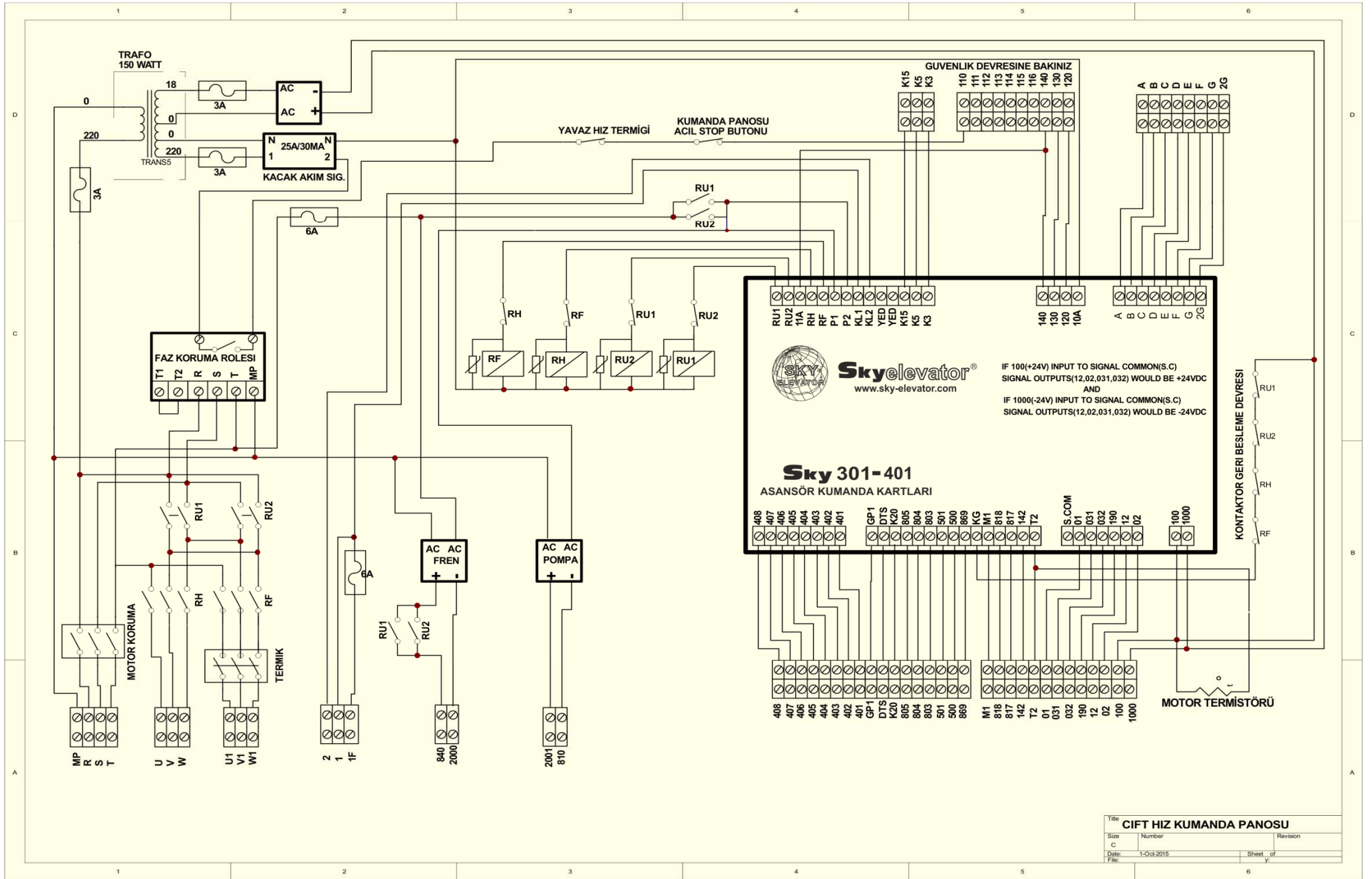

Title		
CİFT HIZ KUMANDA PANOSU		
Size	Number	Revision
C		
Date:	1-Oct-2015	Sheet_of
File:		y

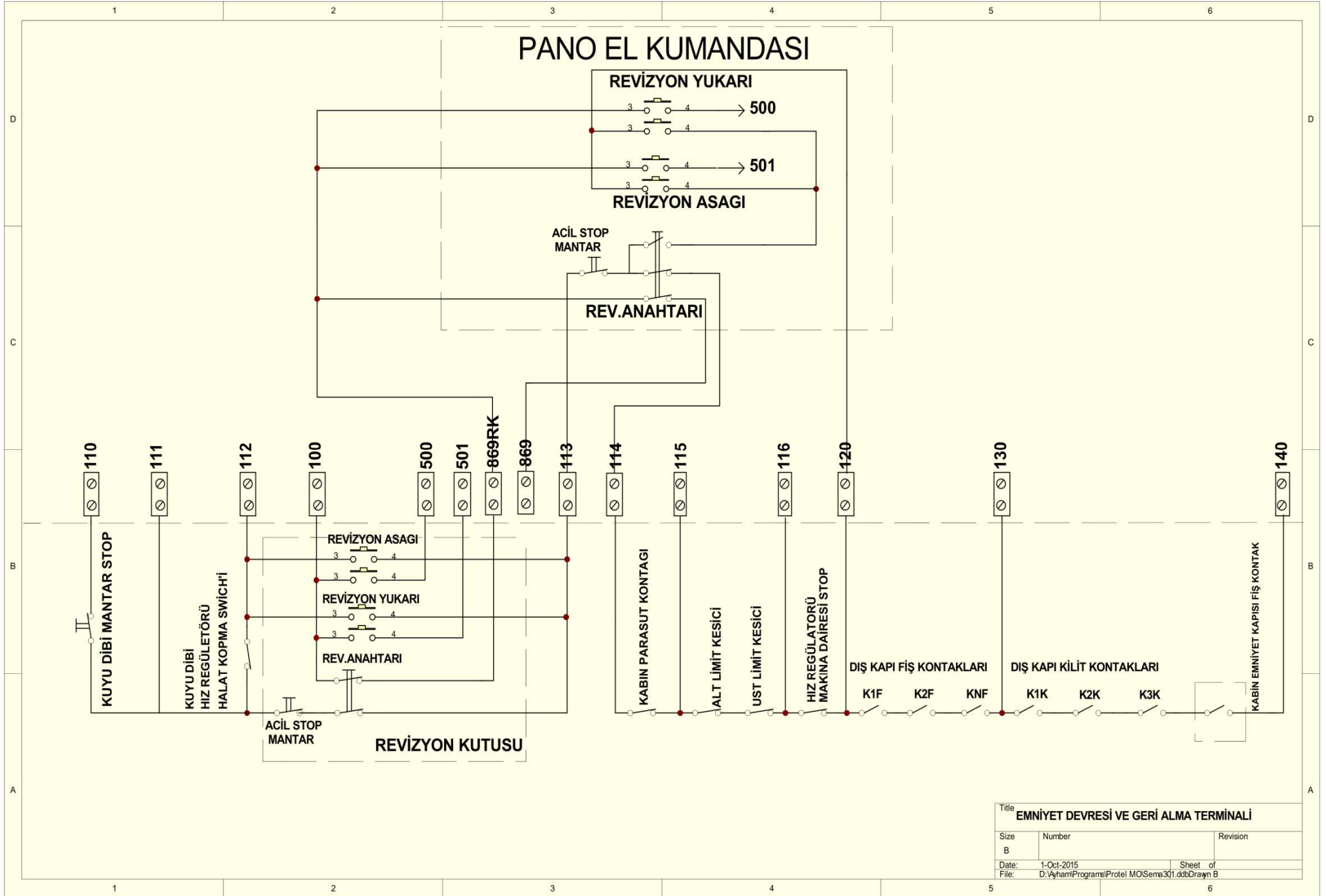

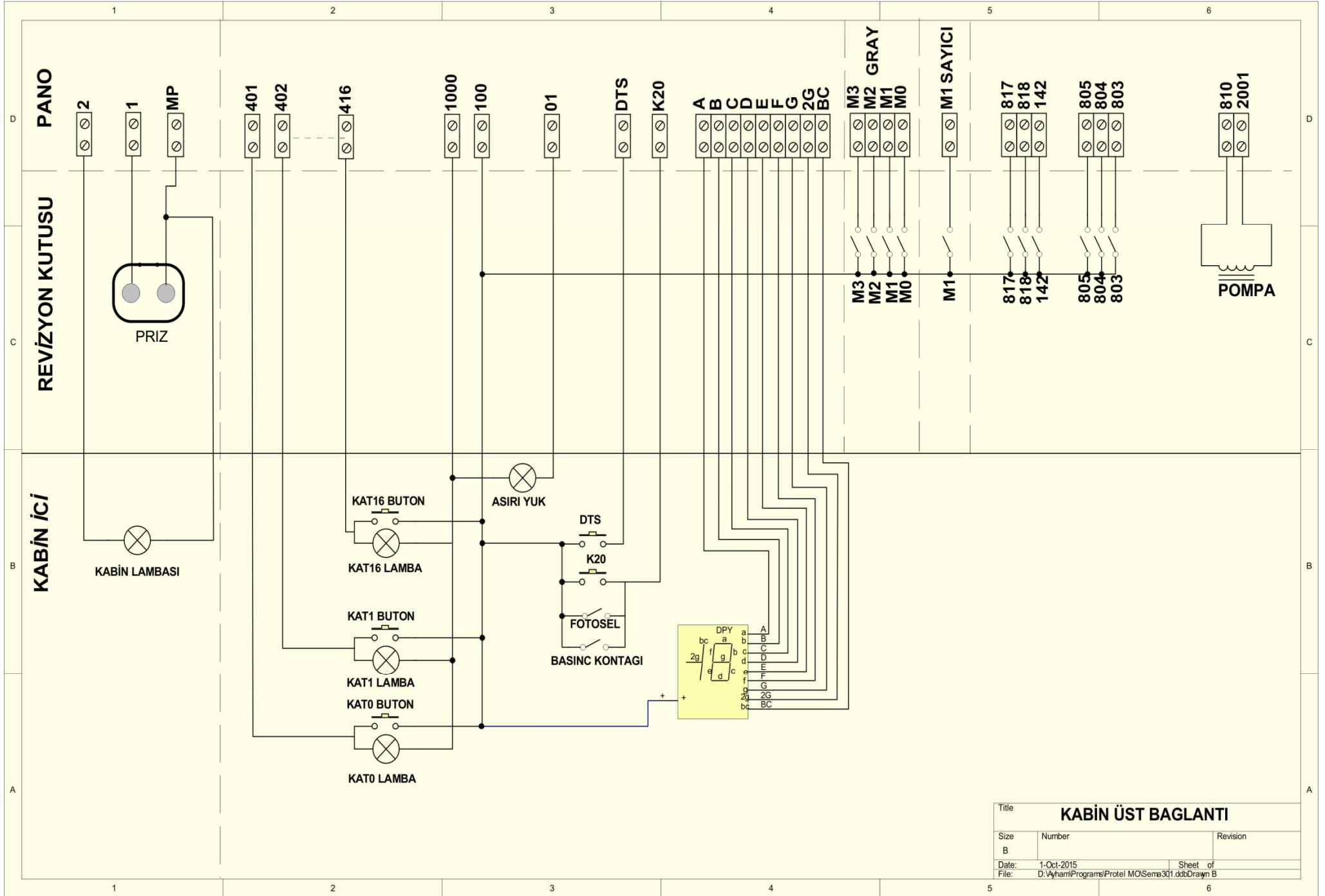

Title		
<b>KABİN ÜST BAĞLANTI</b>		
Size	Number	Revision
B		
Date:	1-Oct-2015	Sheet of
File:	D:\yhami\Programs\Protel MO\Sema301.ddb\Drawn B	

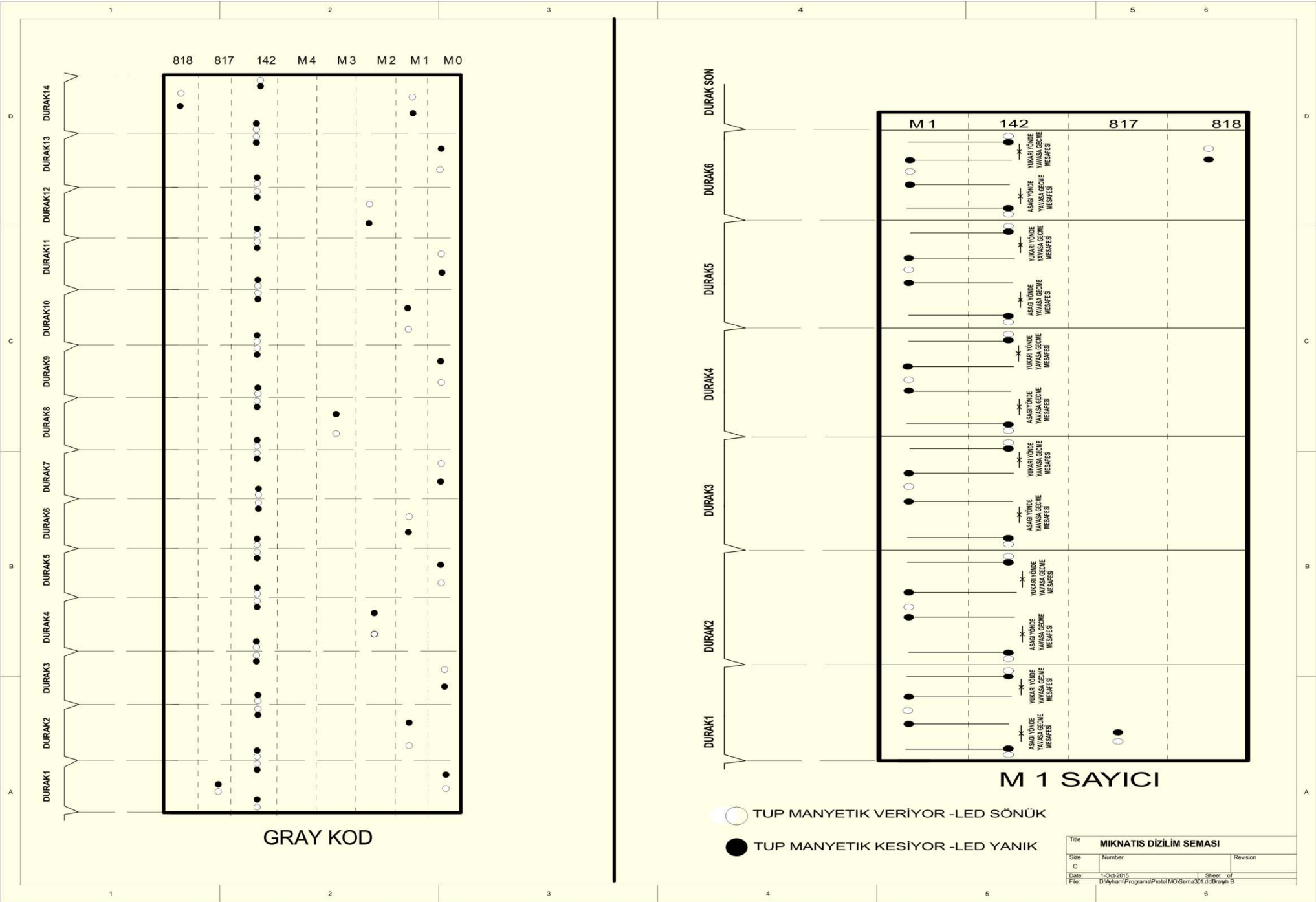

KART ÜZERİNDEKİ SO KLEMENSİNE 1000 VERİLDİ İSE  
SİNYAL LAMBALARI MÜSTEREĞİ 100 OLMALIDIR

BASİT KUMANDA

İÇ/ DİS KARISIK  
TOPLAMA

ASAĞI / YUKARI  
TOPLAMA

ÇİFT BUTON  
TOPLAMA

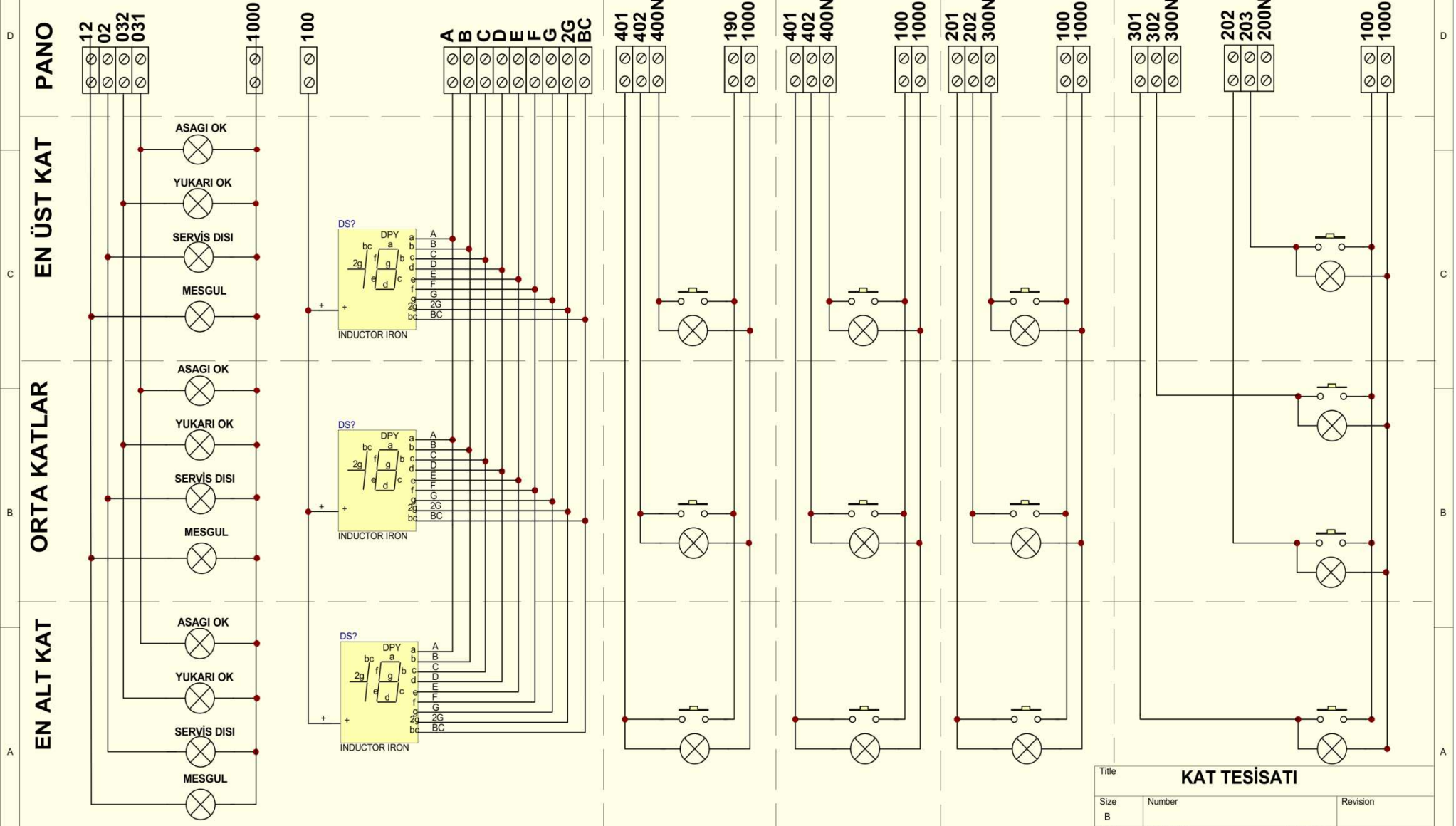

Title		
<b>KAT TESİSATI</b>		
Size	Number	Revision
B		
Date:	1-Oct-2015	Sheet of
File:	D:\yhami\Programlar\Protel MO\Sema301.dtb\Drayn B	

1

2

3

4

5

6

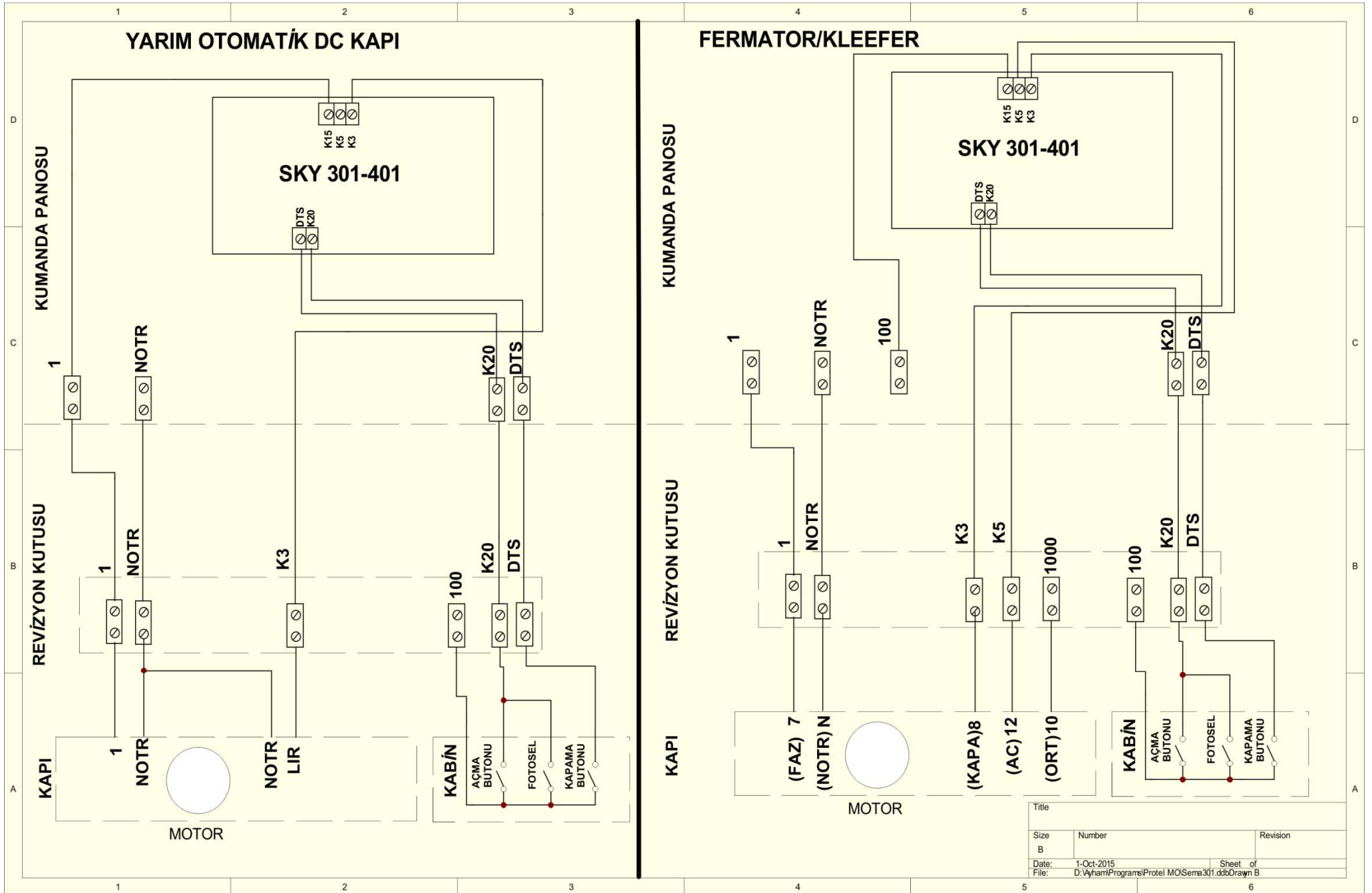

**YARIM OTOMATİK DC KAPI**

**FERMATOR/KLEEFER**

KUMANDA PANOSU

KUMANDA PANOSU

REVİZYON KUTUSU

REVİZYON KUTUSU

KAPI

KAPI

MOTOR

MOTOR

Title		
Size	Number	Revision
B		
Date:	1-Oct-2015	Sheet of
File:	D:\YhamPrograms\Protel MOWSems301.ddb\Drawn B	

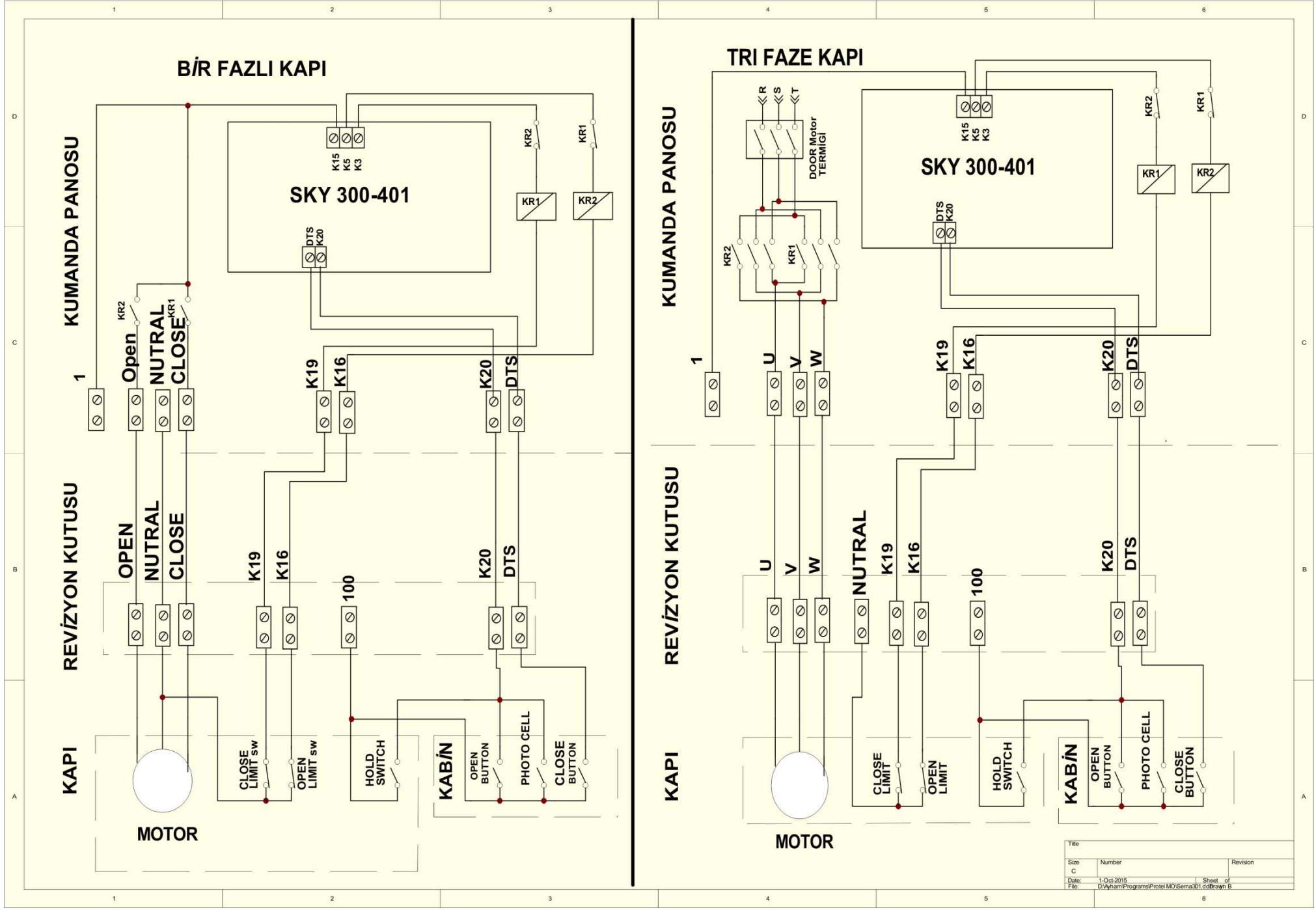

Title		
Size	Number	Revision
C		
Date:	1-Oct-2015	Sheet of
File: D:\yham\Programs\Protel MO\Sema301.docDrawn B		



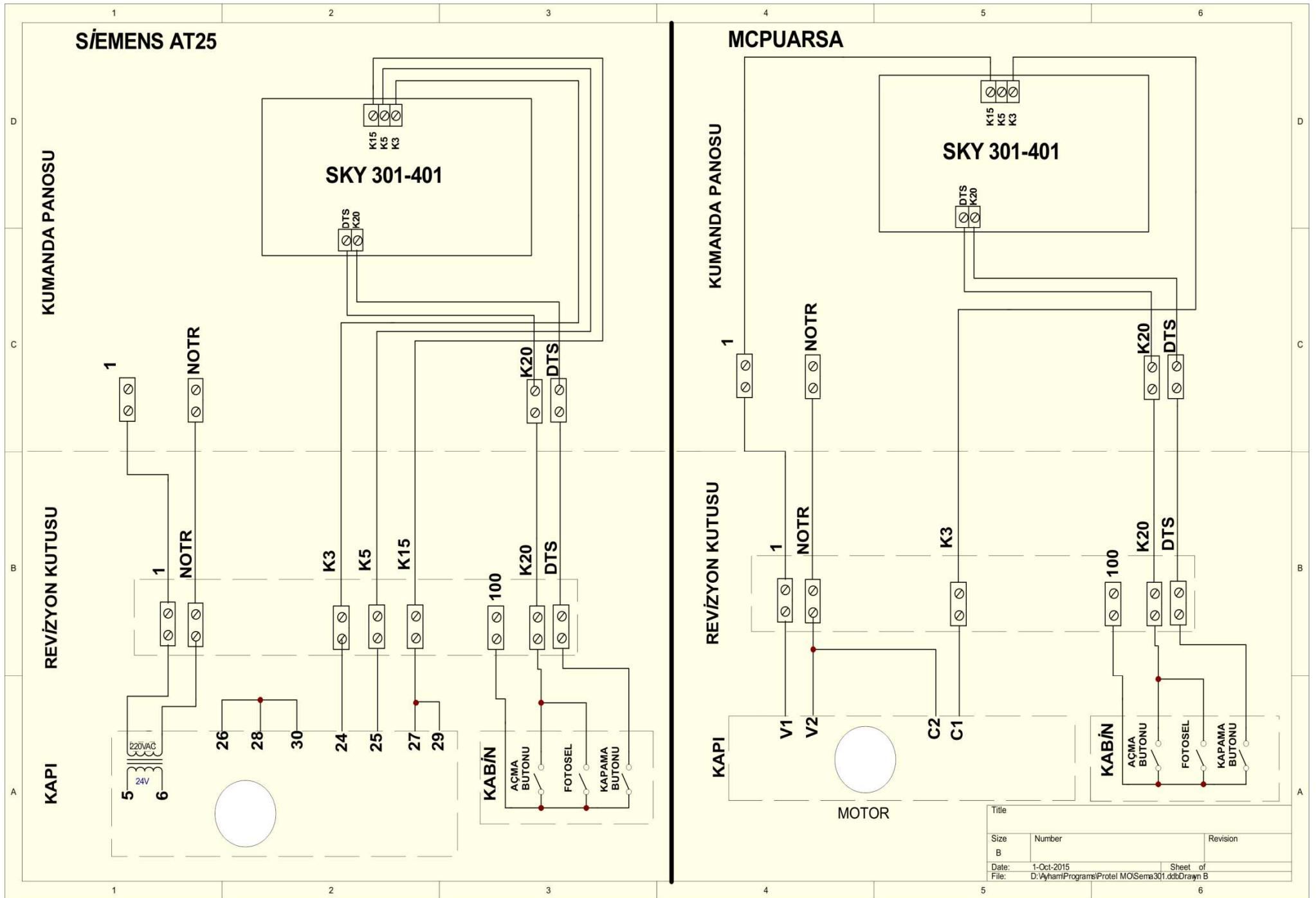

Title		
Size	Number	Revision
B		
Date:	1-Oct-2015	Sheet of
File:	D:\Yham\Programs\Protel MO\Sema301.dcb\Drawn B	